

Advantages:

- Small size, better low frequency, high sensitivity.
- Can be used in Earphone.
- Can be used for IPX7 Waterproof.

Mechanical data:

- Weight:0.32g
- Dimension:

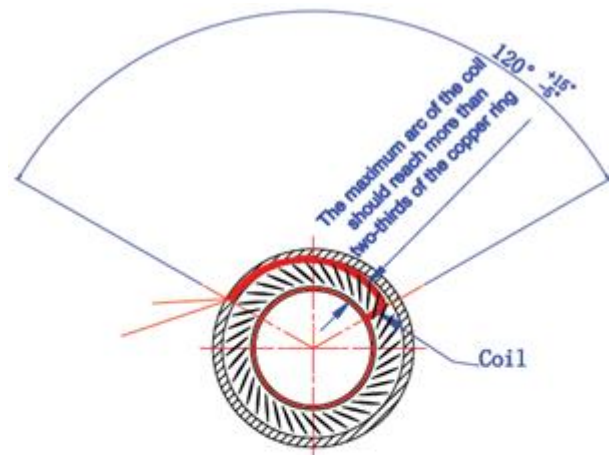
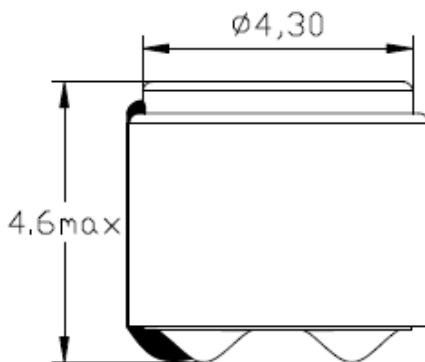
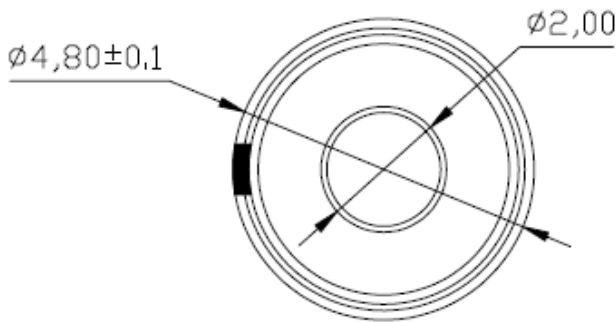

Diaphragm and Voice coil Ass'm

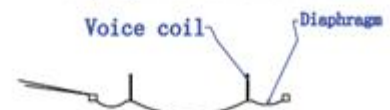

AMTACOUSTIC

ADS-SM-4.8-43-002

Update: 20191118

Electrical and Acoustic Properties:

Item	Spec	Unit
Dynamic Dimension	Phi 4.8 x 4.6	mm
Material of Diaphragm	TPU	
Material of Voice Coil	Copper 2 layers	
Sensitivity at 1kHz	89±3dB@1KHz	dB
DCR	43± 15%	Ohm
F0	1000±20%	Hz
THD	≤3% (50~10KHz)	%
Normal Power	3	mW
Max. Power	5	mW
Waterproof Level	IPX7 (Under 1m water for 30min)	
BUZZE & RATTLES	Must be free audible noise From 50 Hz to 3KHz frequency range, Input : 0.359 VRms	

Acoustic specification:

1, Test condition

- 1.1 Test voltage: DC 207mVrms
- 1.2 Test fixture: IEC318Ear
- 1.3 Source requirements: source impedance <1ohm.

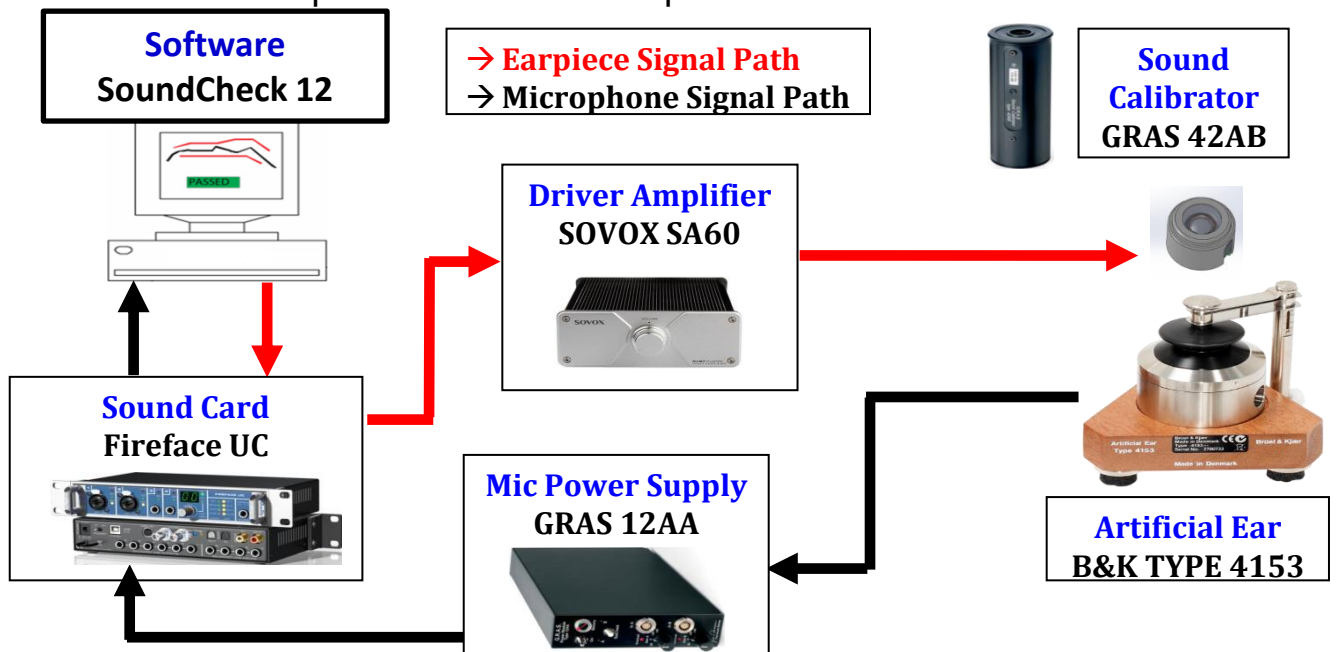

2, Acoustic Test Result.

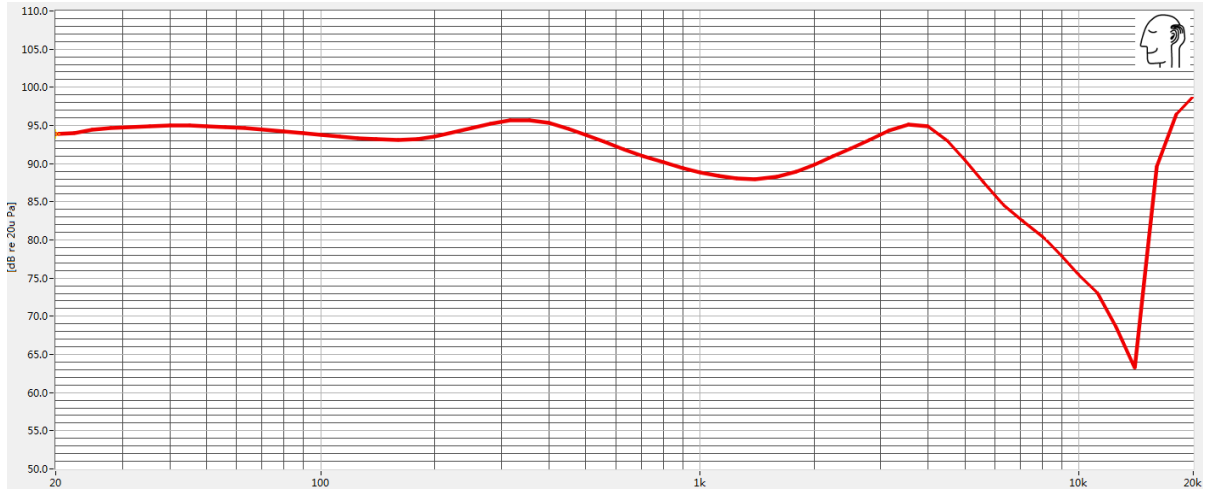

Frequency Response

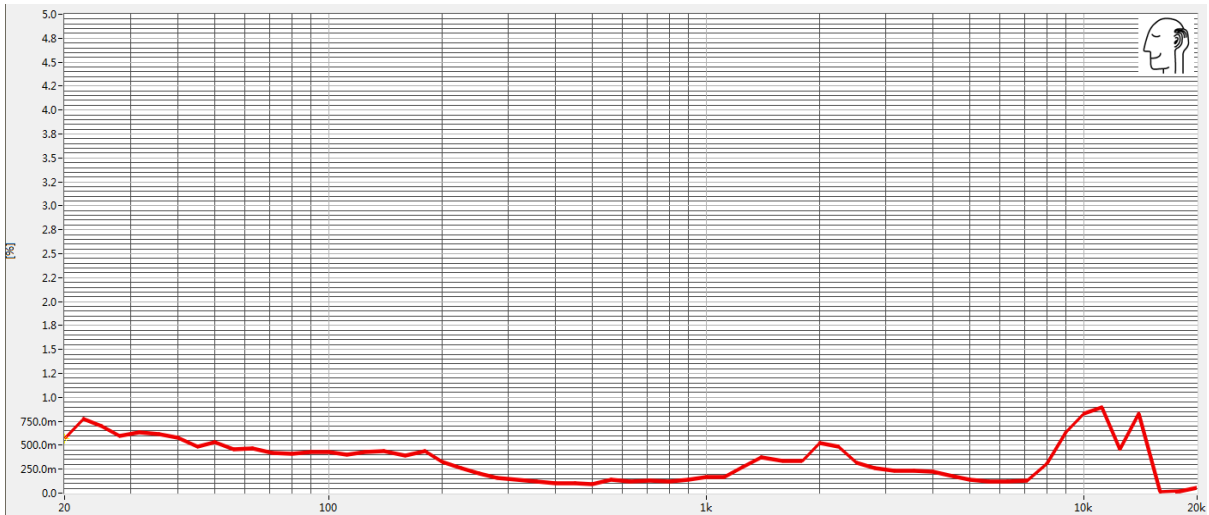

THD

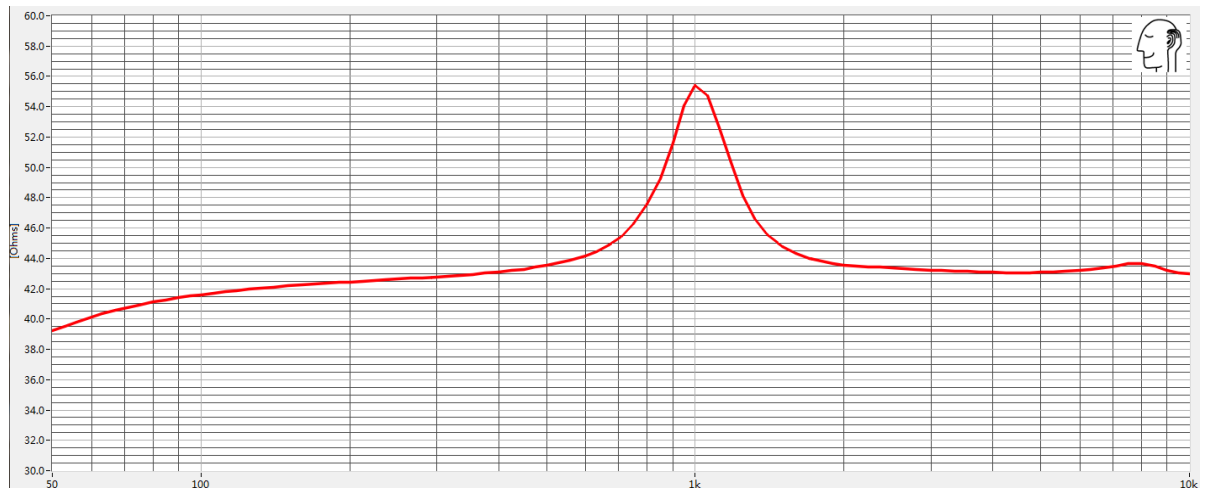

Impedance

Storage and operating requirements:

- Follow below table:

Item	Temperature (°C)	Humidity (%RH)	barometric pressure (hPa)
Storage	-40 ~ 63	10 ~ 60	500 ~ 1060
Operating/test	-20 ~ 70	45 ~ 85	860 ~ 1060
Judgment	18 ~ 22	60 ~ 70	860 ~ 1060

Reliability test**3.1 Continues power on test**

Condition: 5mw Pink noise; Approximate test time 96h

Pass/fail criteria: Unaffected performance after the test.

3.2 Free fall test

Condition: 1m (To Hard wood) ; Model of operation: Power off

Approximate test time : total 10 times

Pass/fail criteria: Unaffected performance after the test.

3.3 Cold, non-operational

Condition: Temperature:-40°C; Model of operation: Power off

Approximate test time 96 h

Pass/fail criteria: Unaffected performance after the test(At room temperature for 4H).

3.4 Heat, non-operational

Condition: Temperature:+70°C; Model of operation: Power off;

Approximate test time 96 h

Pass/fail criteria: Unaffected performance after the test

3.5 Temperature and humidity cycling, non-operational

Condition: Temperature:-30°C~70°C, 90%RH

Model of operation: Power off

Approximate test time : 4H/cycle, total 15 cycle

Pass/fail criteria: Unaffected performance after the test

Website: www.china-armature.com

Office Tel: (+86) 0519-81882133

Mail box: sales@china-armature.com

Address: No.7 Lanxiang Road economic development zone

Wujin district Changzhou City China